



TEST REPORT
For
JXWBLB-T-BP-750-500-LS



Technical Specification

1dB Pass Band (MHz)	500~1000
Center Frequency(MHz)	750
1dB Bandwidth(MHz)	500 min
I.L. at Center Frequency(dB)	1.0 max
Pass Band Loss(dB)	1.5 max
Stop Band 1(dB)	60 min @ 300 MHz
Stop Band 2(dB)	60 min @ 1200 MHz
VSWR	1.5 Typ.
Connector	SMA-Female
Net Weight(Kg)	0.02 Around

Outline Drawing (Size: mm)

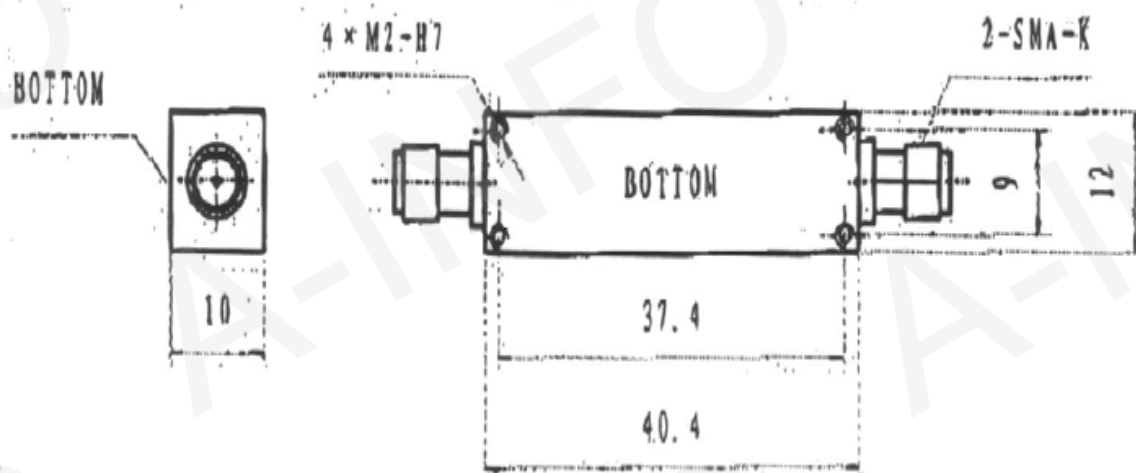

Test Results

Temperature	Insertion Loss (dB)			Rejection (dB)		VSWR max
	750 MHz	500 MHz	1000 MHz	300 MHz	1200 MHz	
Low Temperature	-0.37	-0.53	-0.71	-75.1	-72.9	1.5
High Temperature	-0.41	-0.60	-0.78	-74.1	-72.1	1.5
Room Temperature	-0.43	-0.57	-0.74	-73.8	-73.1	1.5