



Test report is for reference only.

TEST REPORT
For
JXWBLB-T-BP-10500-1000-9CS



Technical Specification

1dB Pass Band(GHz)	10.0-11.0
Insertion Loss(dB)	1.5 max
Rejection(dB)	35 min @ 9.7GHz 39 min @ 11.3GHz
VSWR	1.5 max
Impedance(Ohms)	50
Connector	SMA-Female
Operating Temperature(°C)	-30 ~ +70
Net Weight(Kg)	0.07 Around

Outline Drawing (Size: mm)

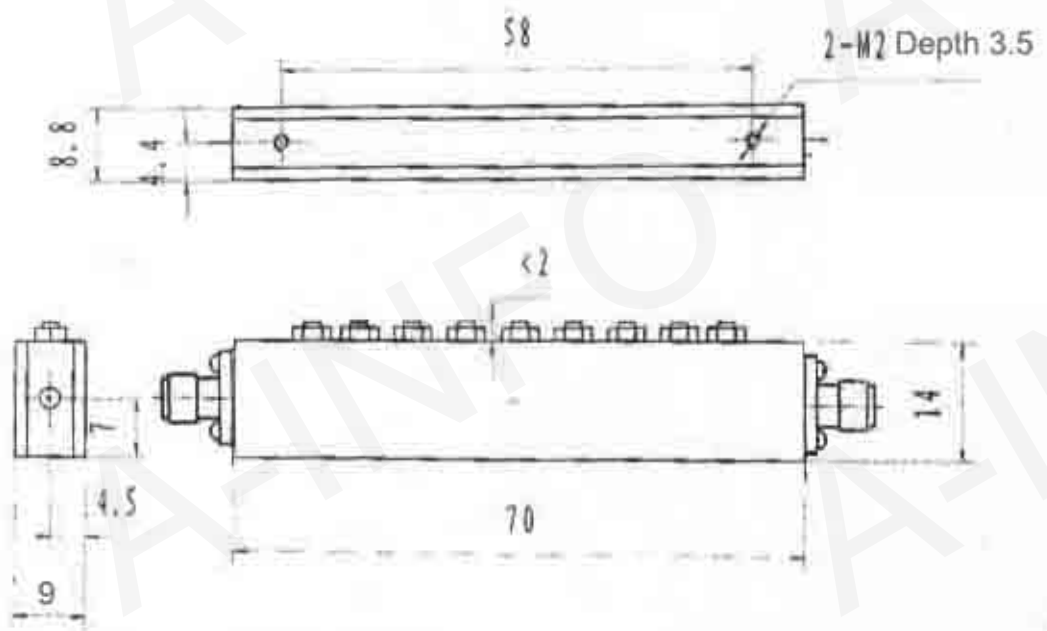

Test Results

Temperature	Insertion Loss(dB)			Rejection(dB)		VSWR
	10.0GHz	10.5GHz	11.0GHz	9.7GHz	11.3GHz	
Low Temperature	-1.12	-0.52	-1.05	-49.6	-48.1	1.44
High Temperature	-0.94	-0.66	-1.24	-47.1	-50.2	1.45
Normal Temperature	-1.01	-0.60	-1.13	-48.3	-49.4	1.46