

Technical Specification

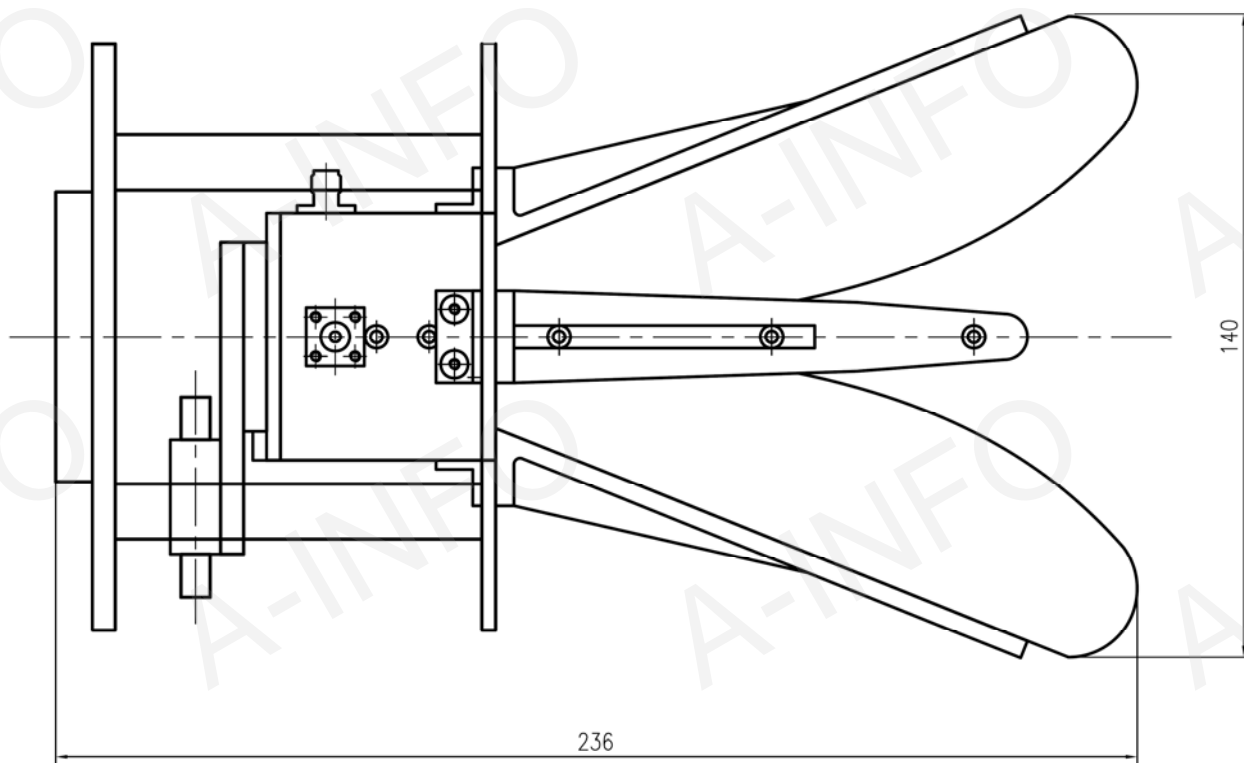

Frequency(GHz)	2 - 18
Gain(dBic)	11.5 Typ.
Axial Ratio(dB)	4.0 Typ.
	9.0 max
Polarization	Dual Circular
VSWR	2.0 max
Connector	SMA-Female
Size(mm)	140x140x236
Net Weight(Kg)	1.1 Around

Outline Drawing (Size: mm)



Test Results

1. Gain

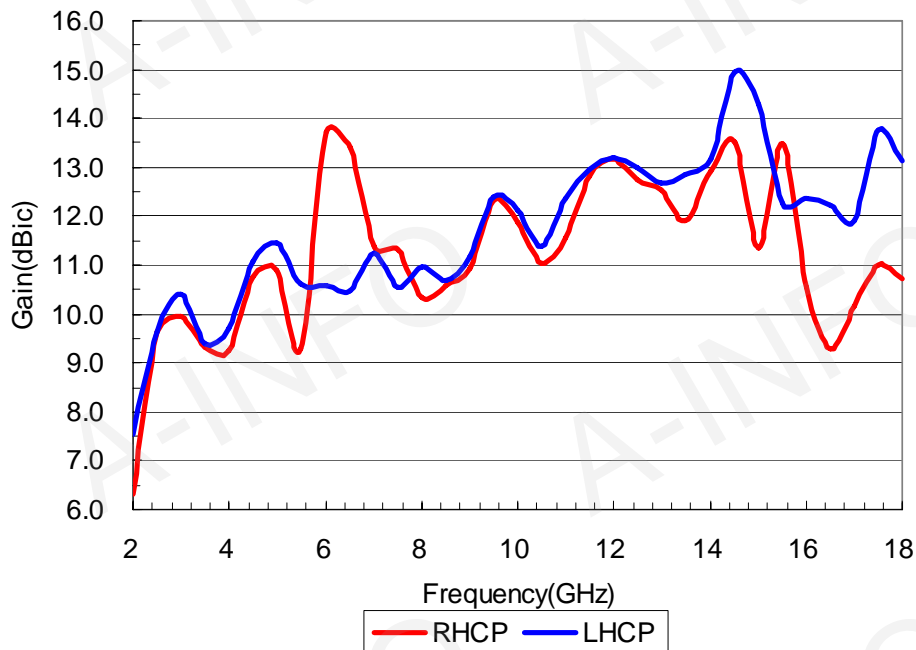

2. Axial Ratio

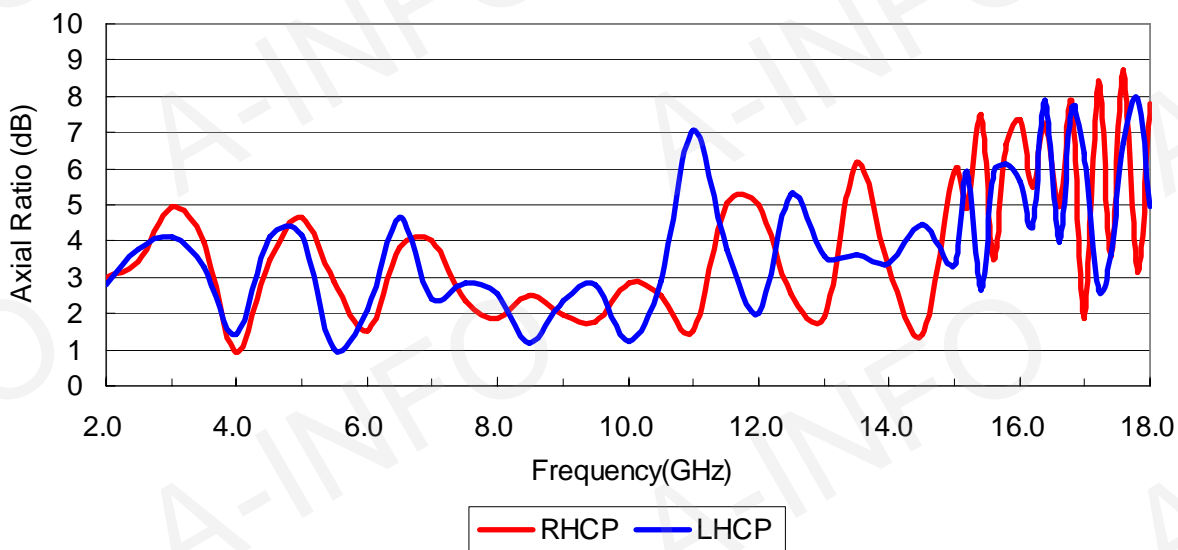

3. VSWR LHCP

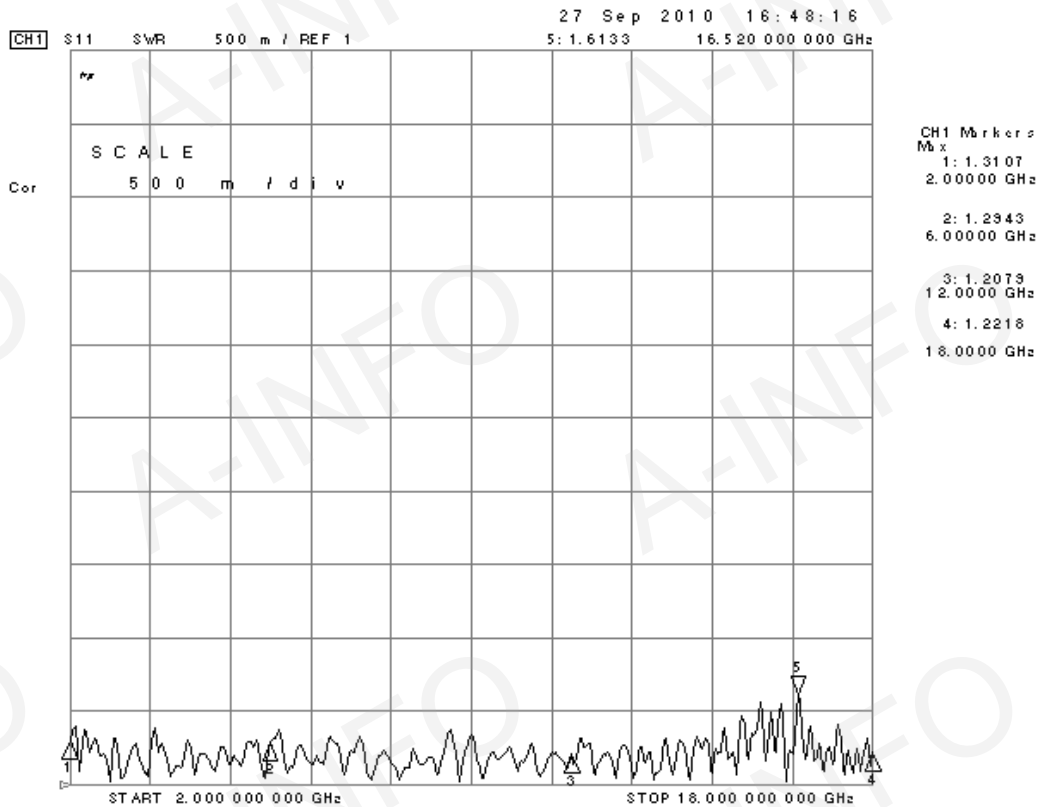

RHCP

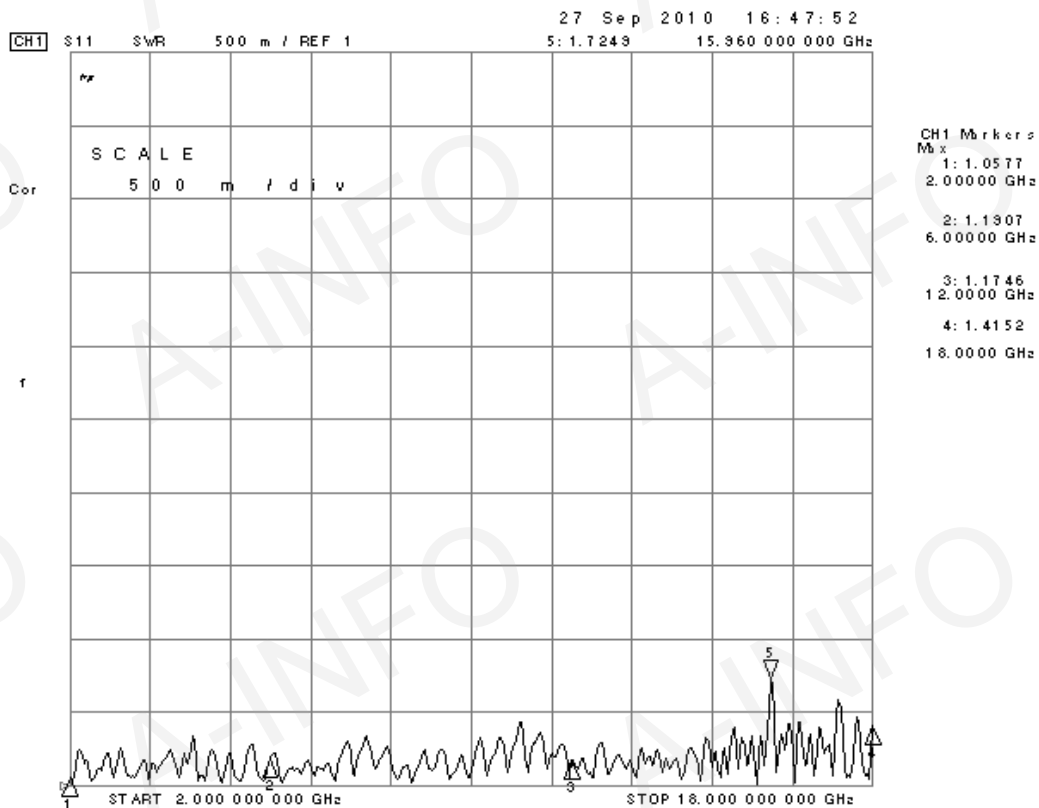

4. Pattern (LHCP)

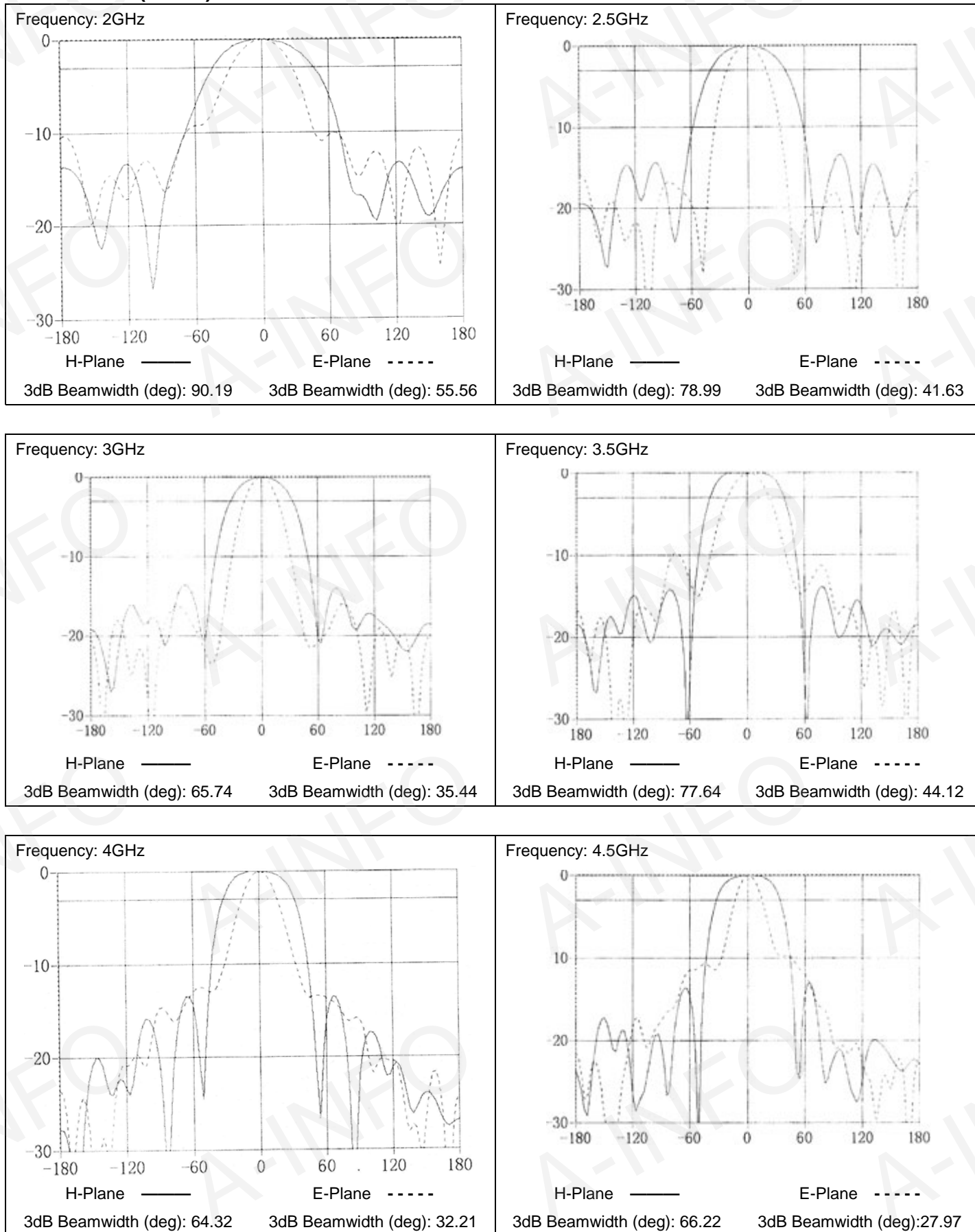

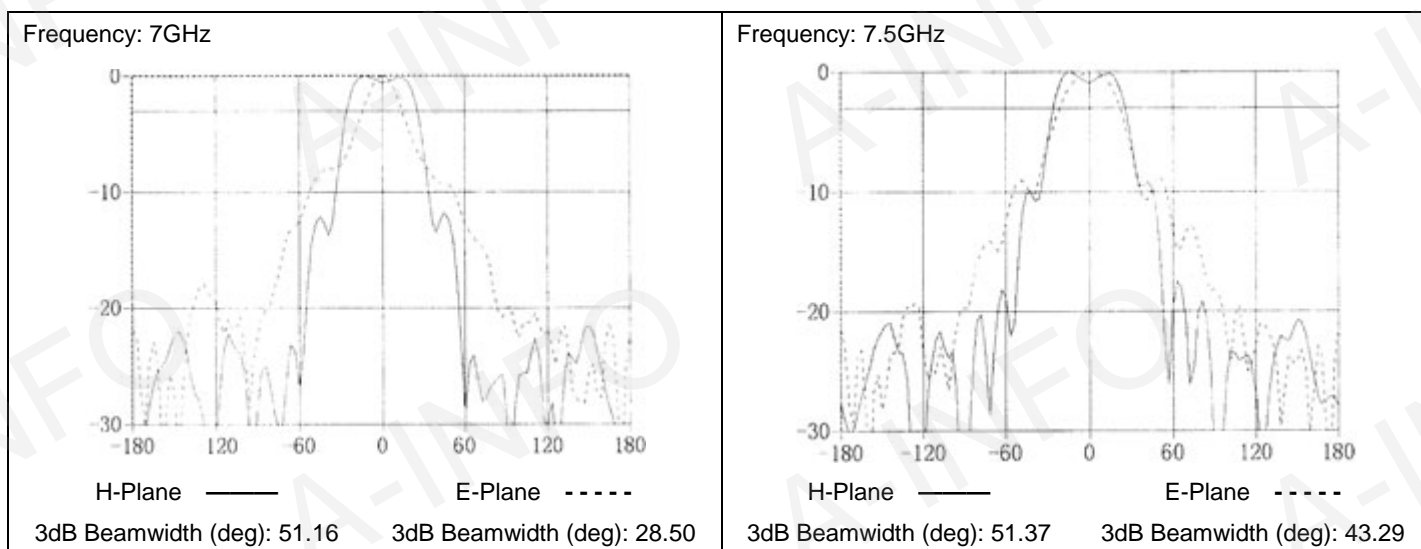
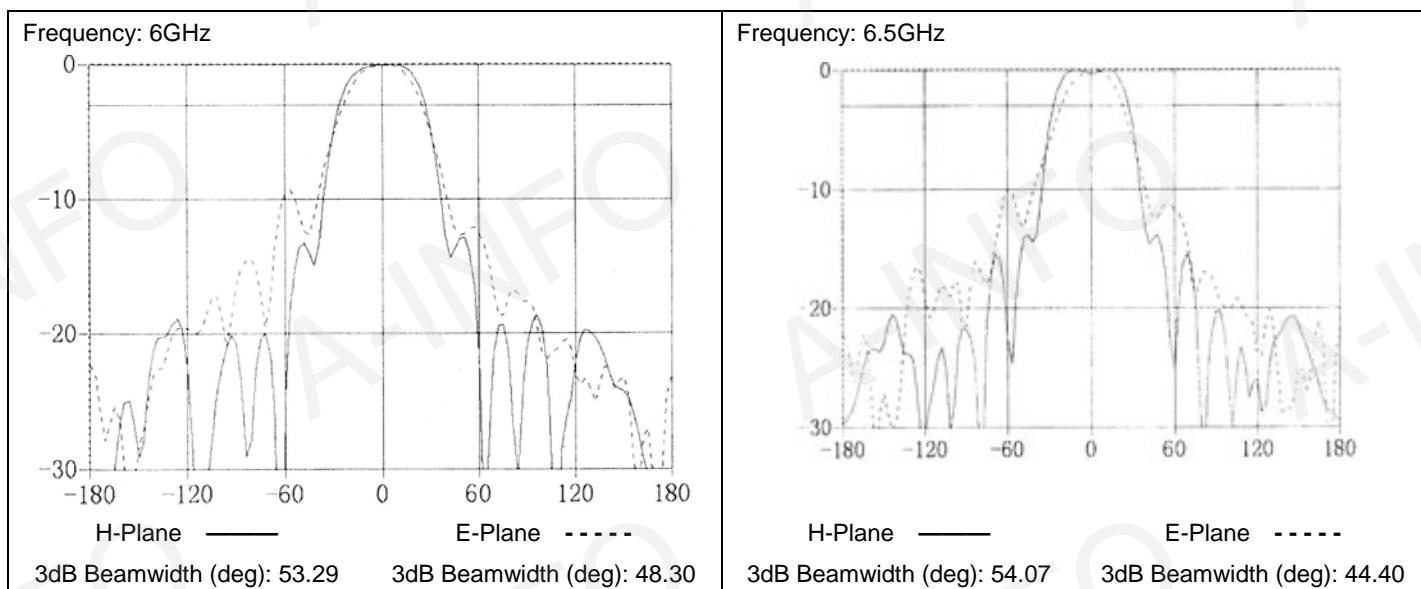
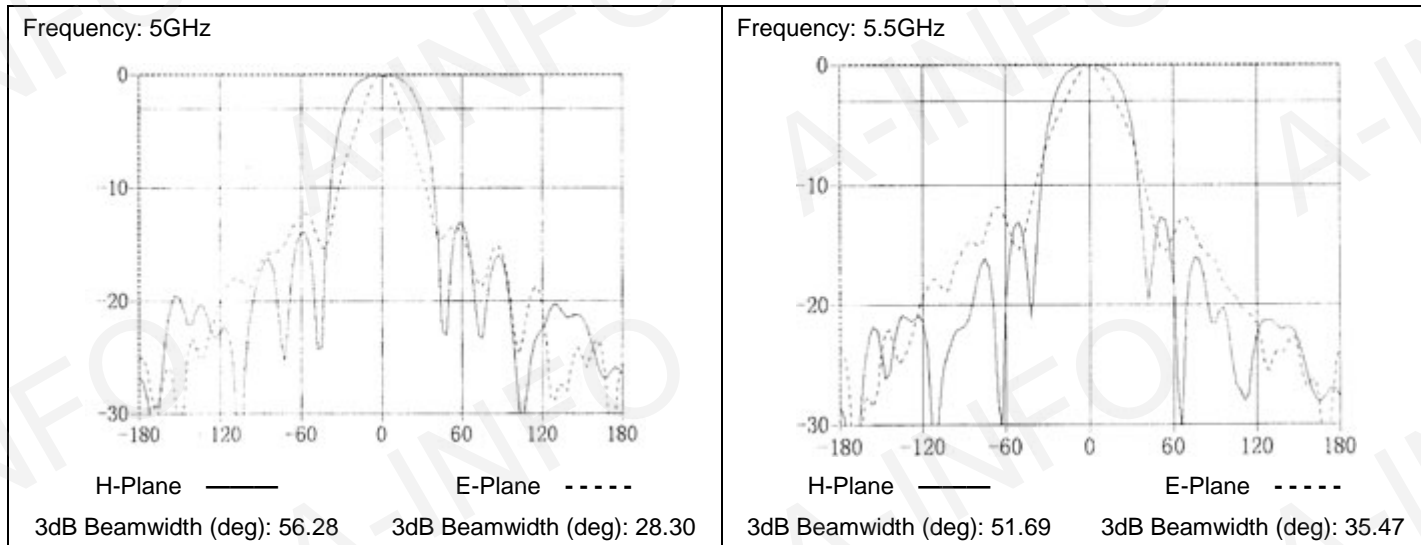

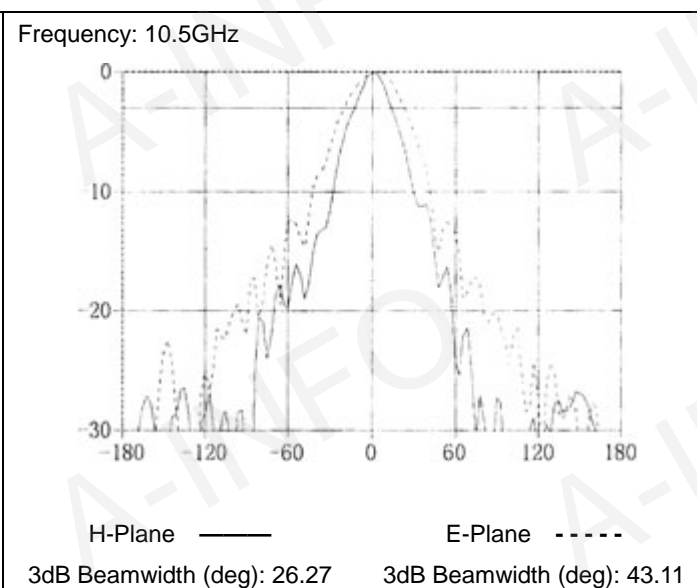
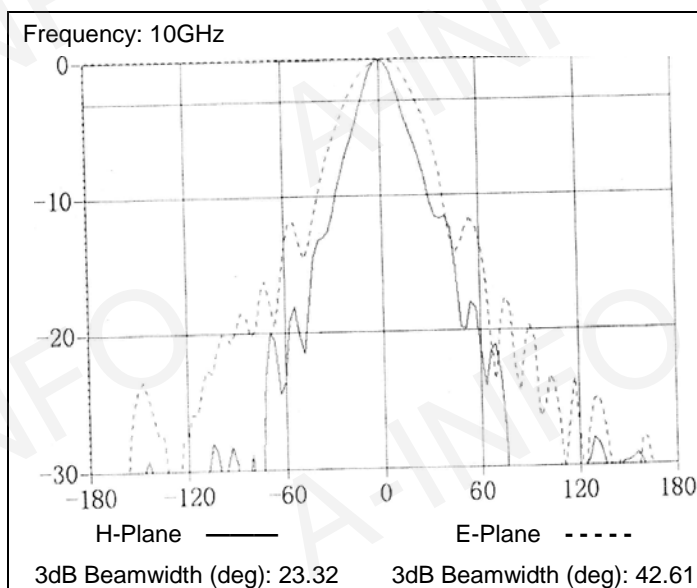
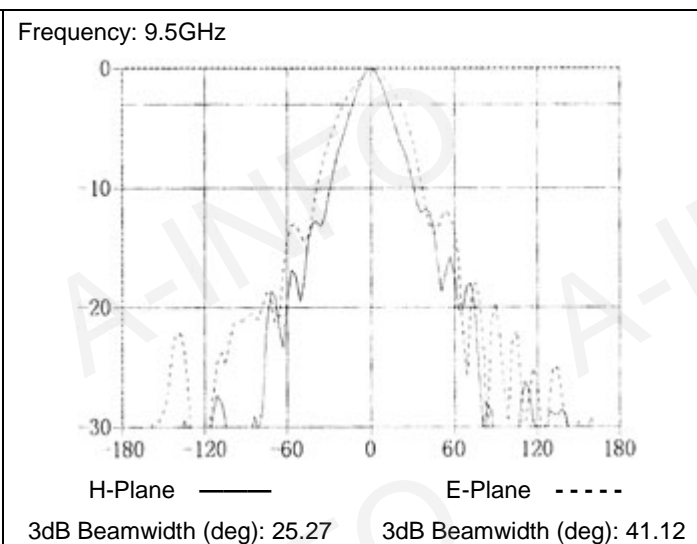
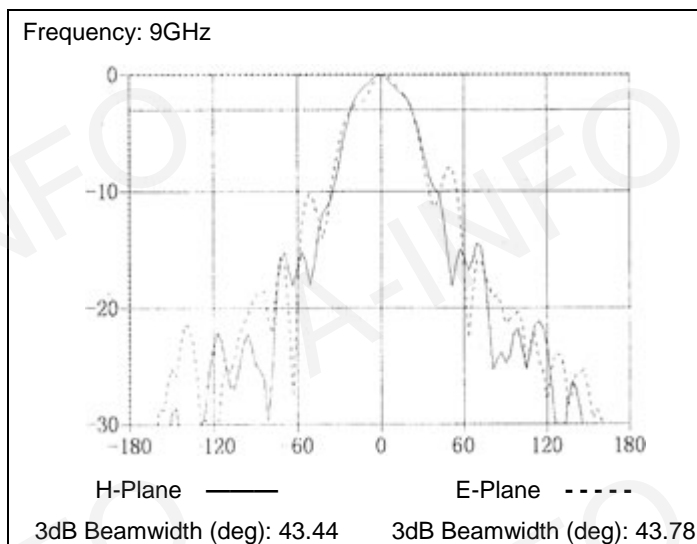
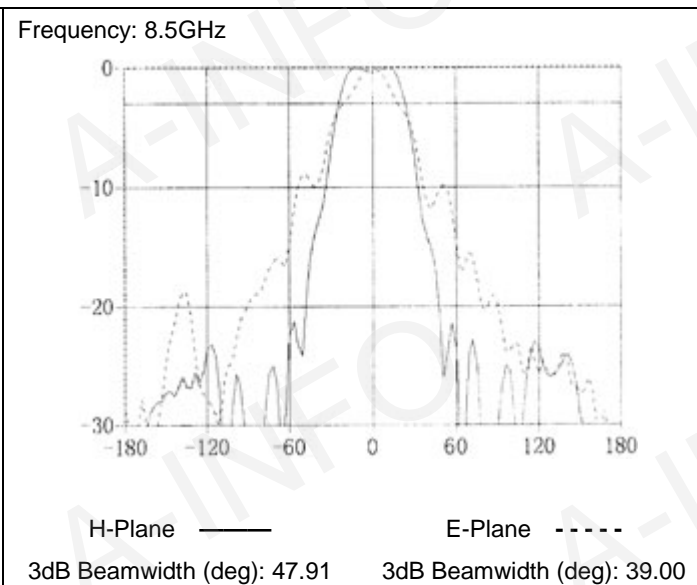
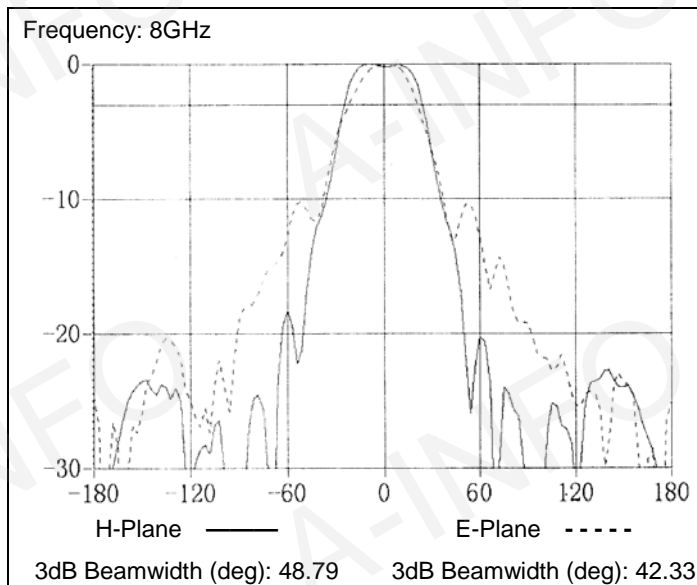

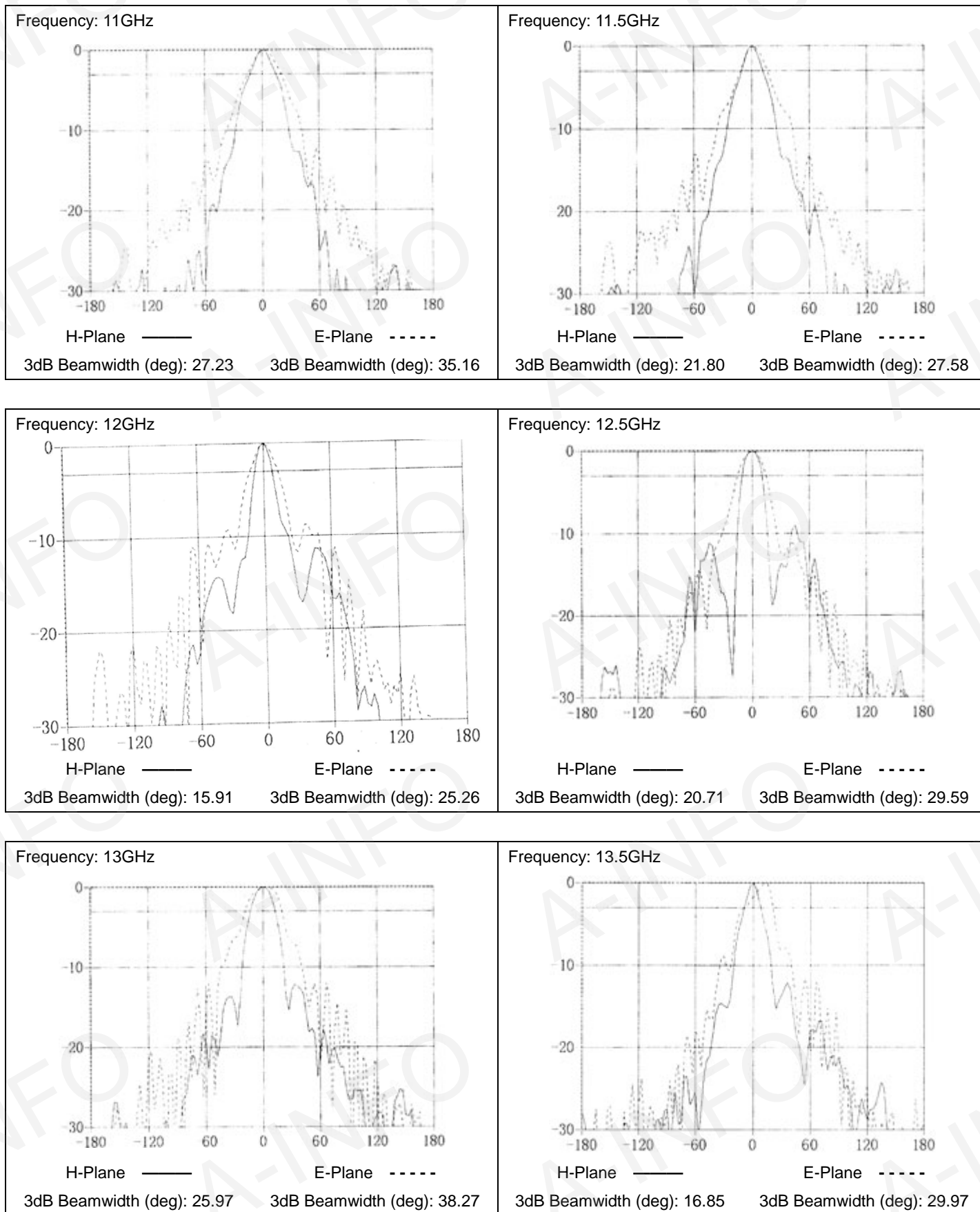

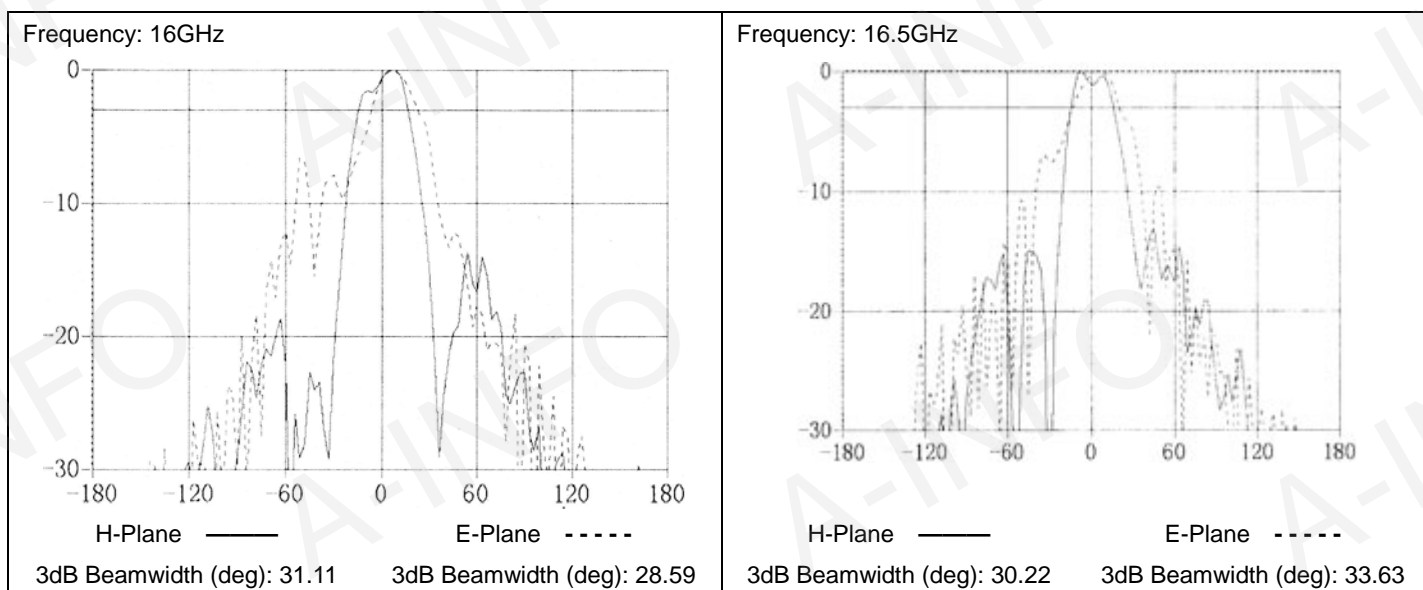
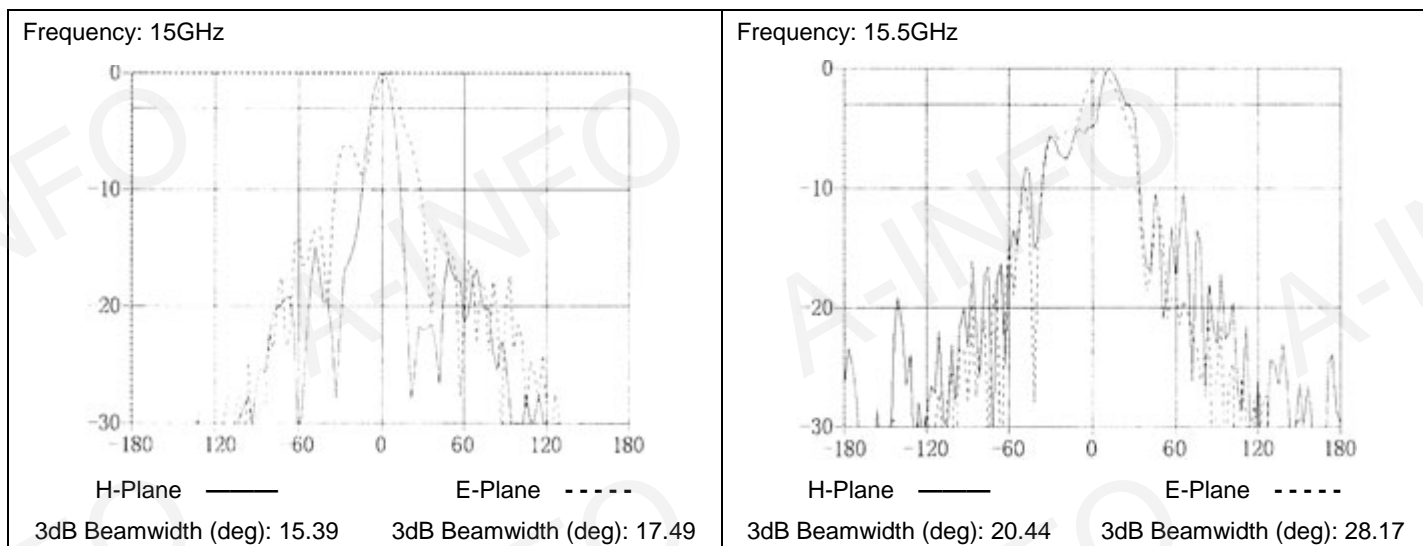
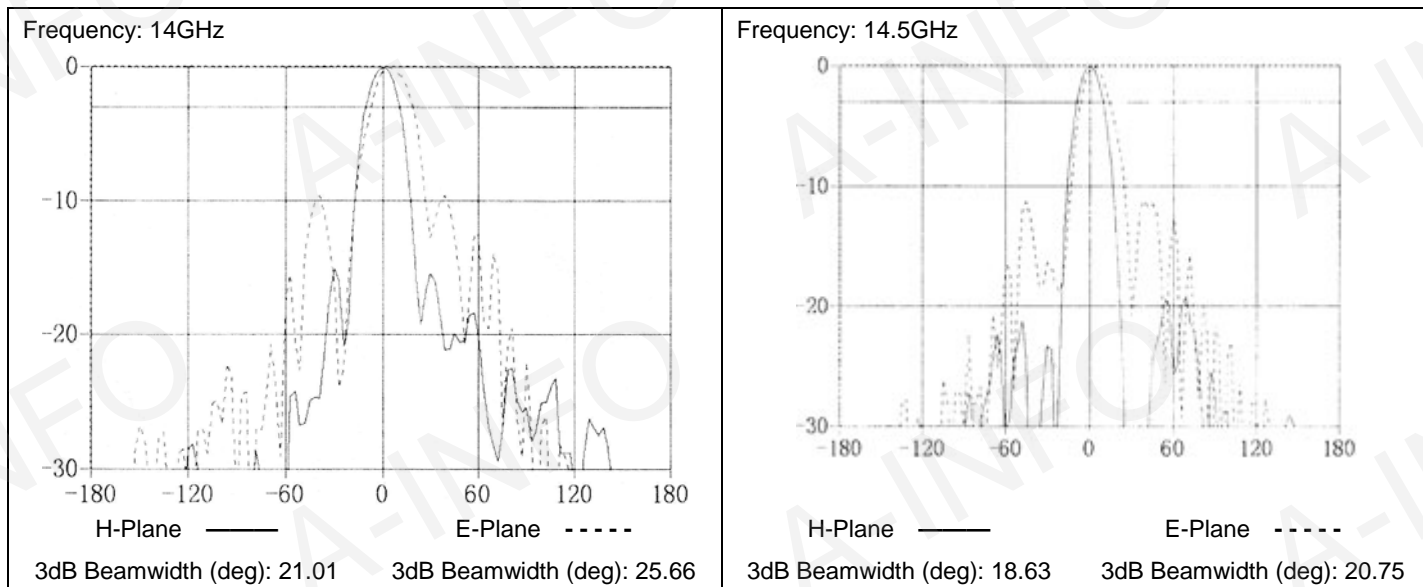

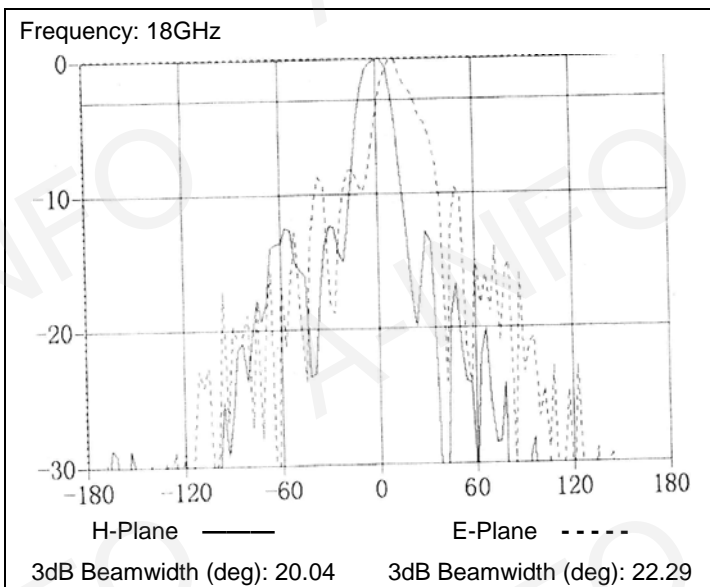
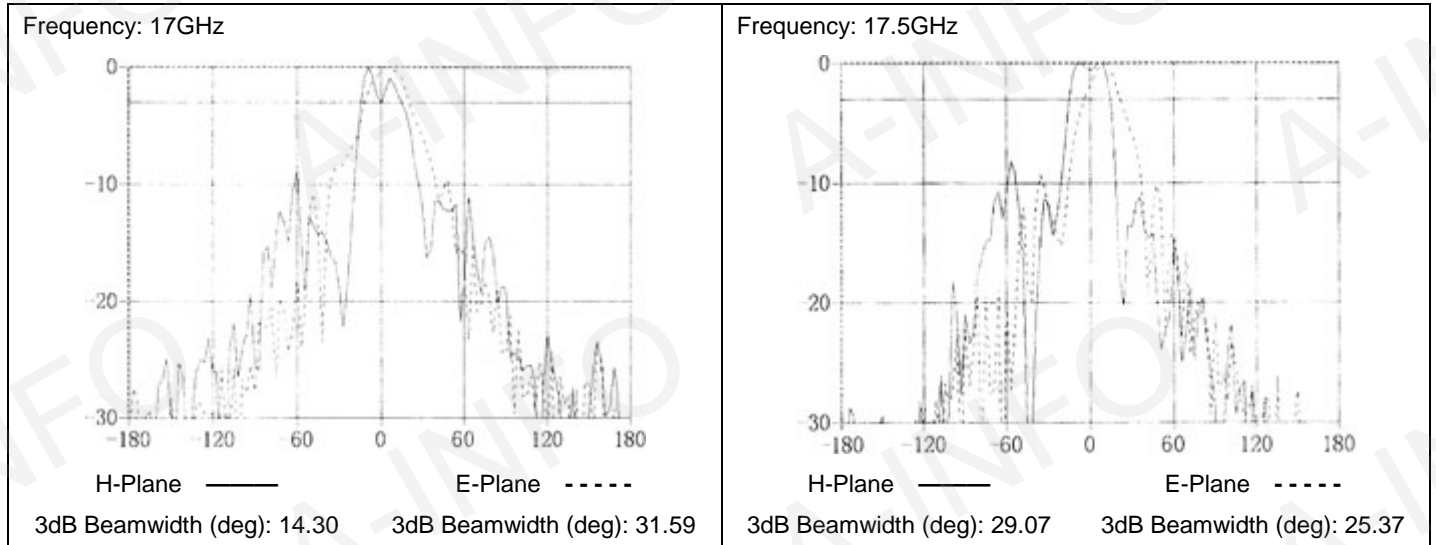

RHCP

