

A Type



C Typ.



## Technical Specification

Frequency Range(GHz)	2.0 - 4.8
Gain(dBi)	15 Typ.
Polarization	Linear
3dBBeamwidth(deg)	40-20
VSWR	2.0 max
Waveguide(A Type)	WRD200D24
Adapter(C Type)	200DRWCAN or 200DRWCAS
Connector(C Type)	N-Female or SMA-Female
Size(mm)	A Type: 245x195x310 / C Type: 245x195x407
Net Weight(Kg)	A Type: 2.0 Around / C Type: 2.5 Around

## Outline Drawing (Size: mm)

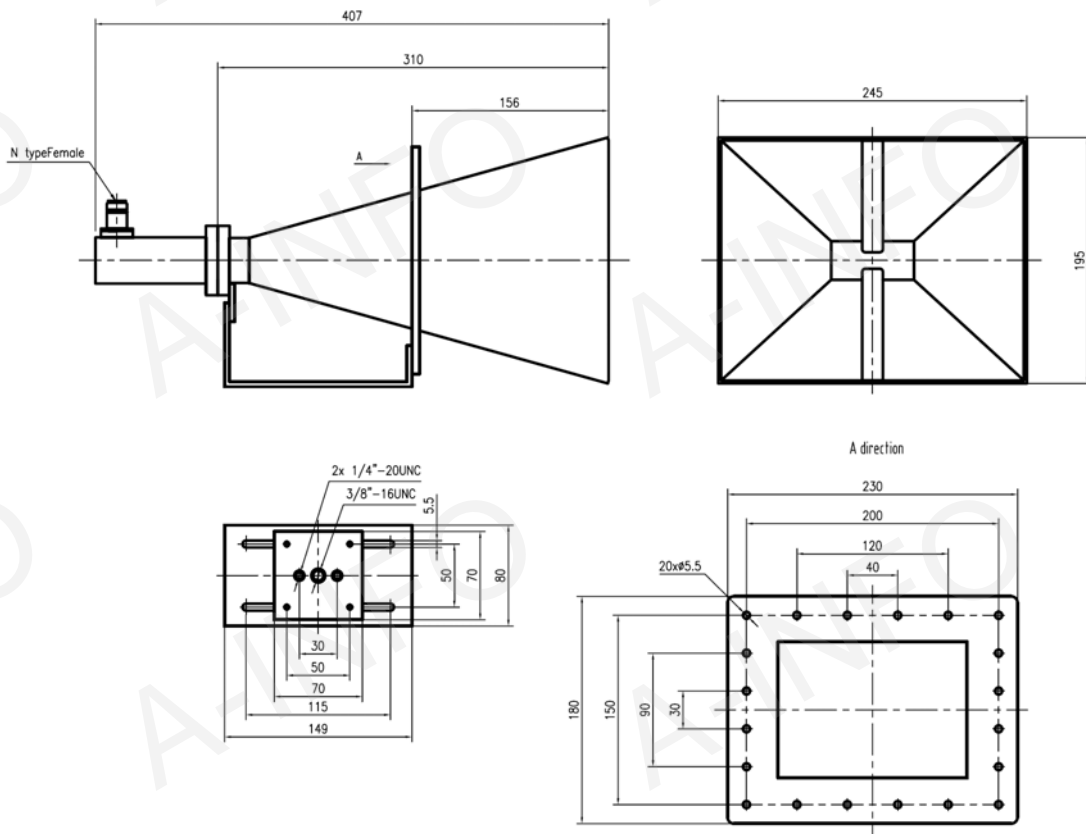

## Test Results

### 1. Gain

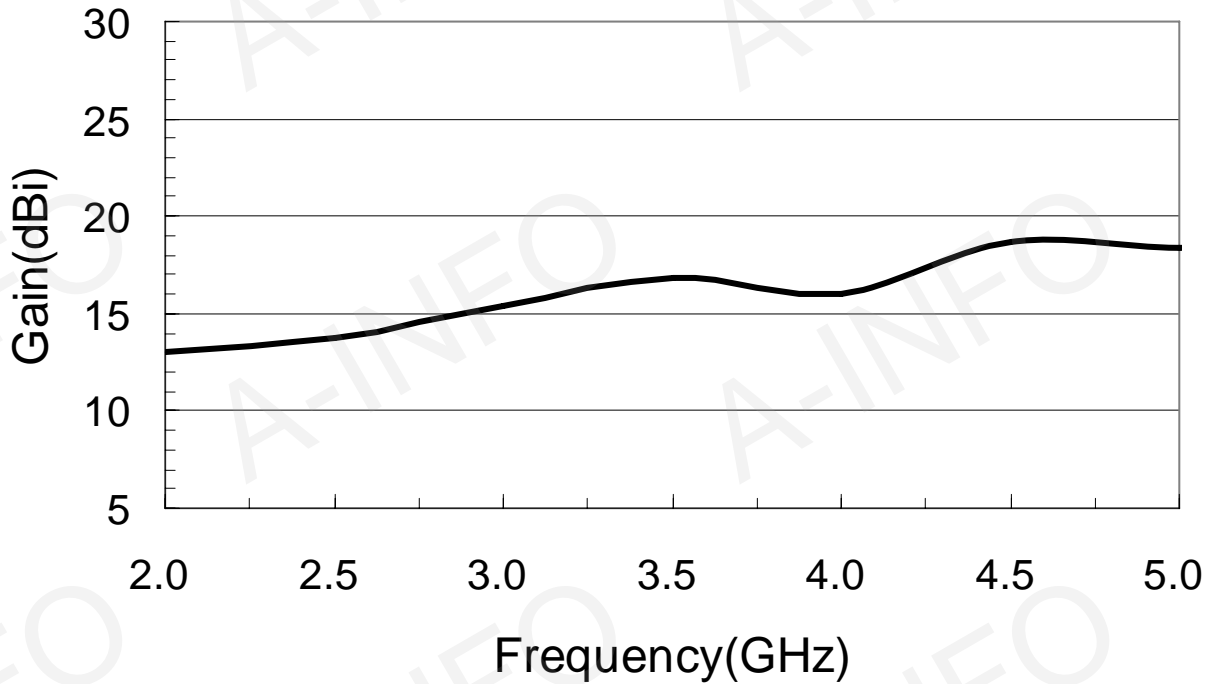

### 2. Antenna Factor@ 1m distance

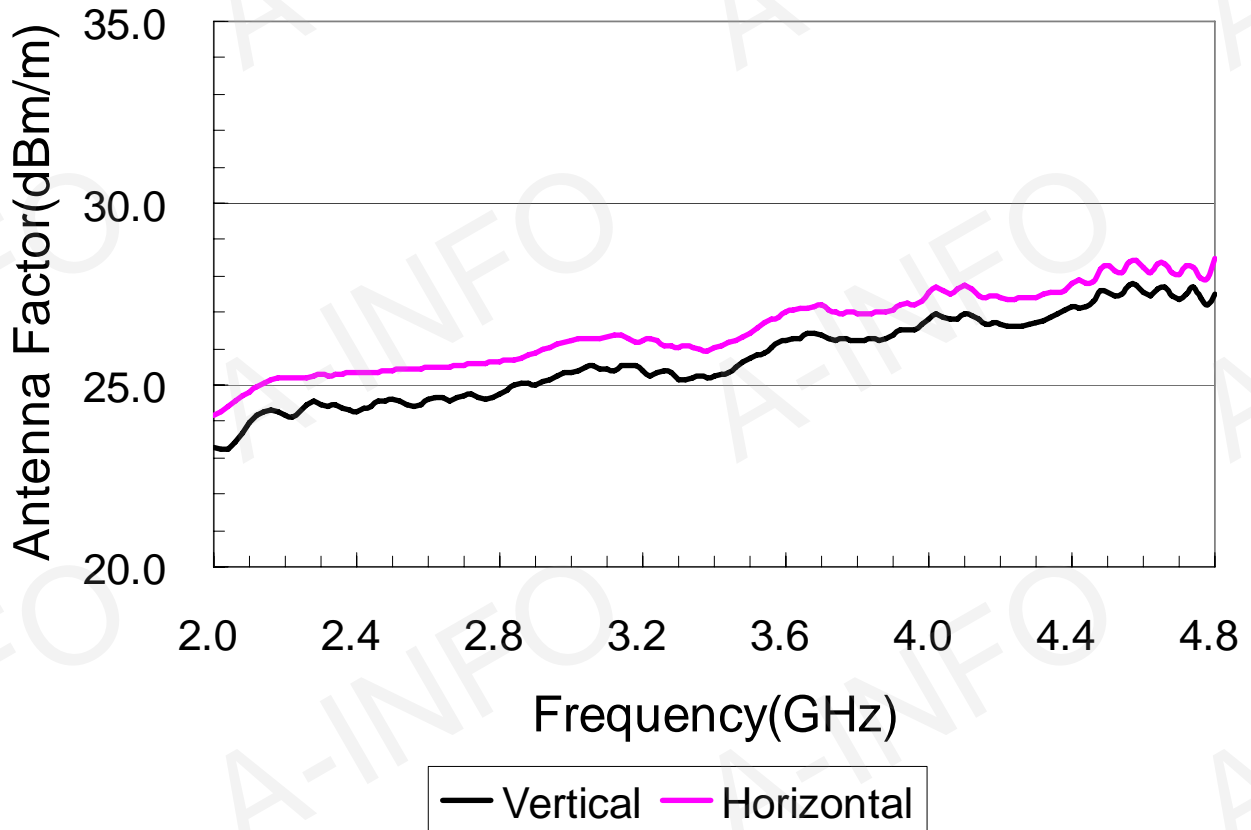

### 3. VSWR

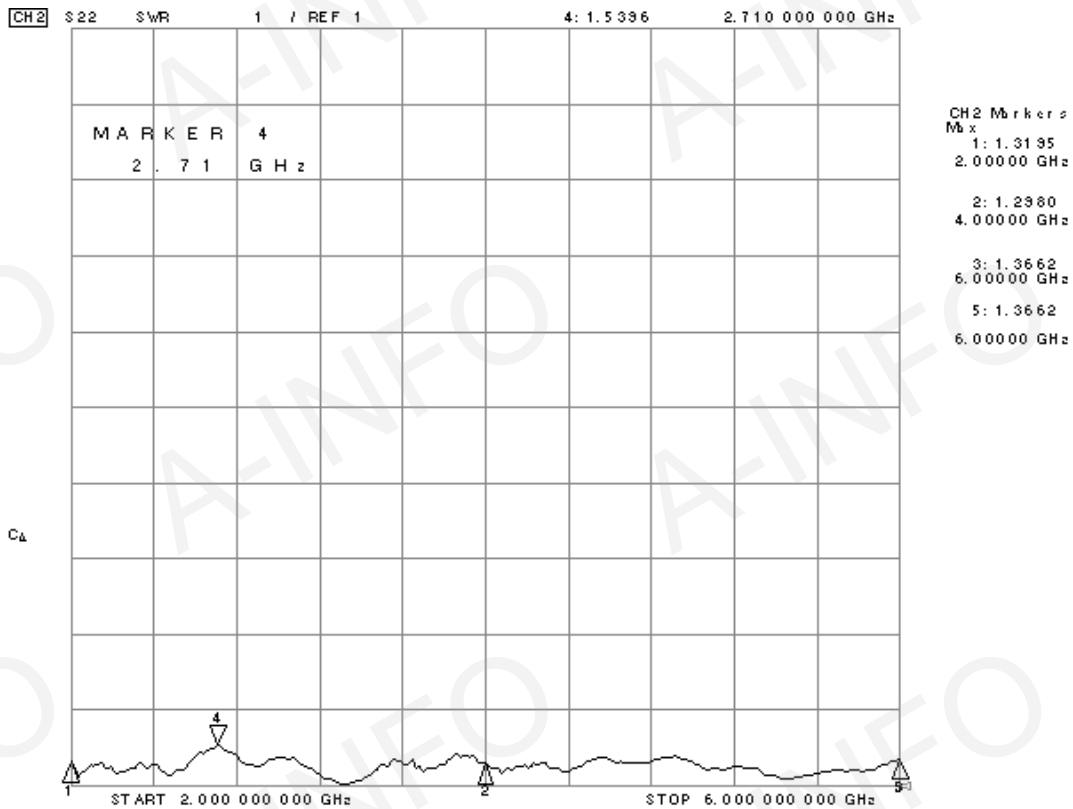

### 4. Cross Polarization Isolation

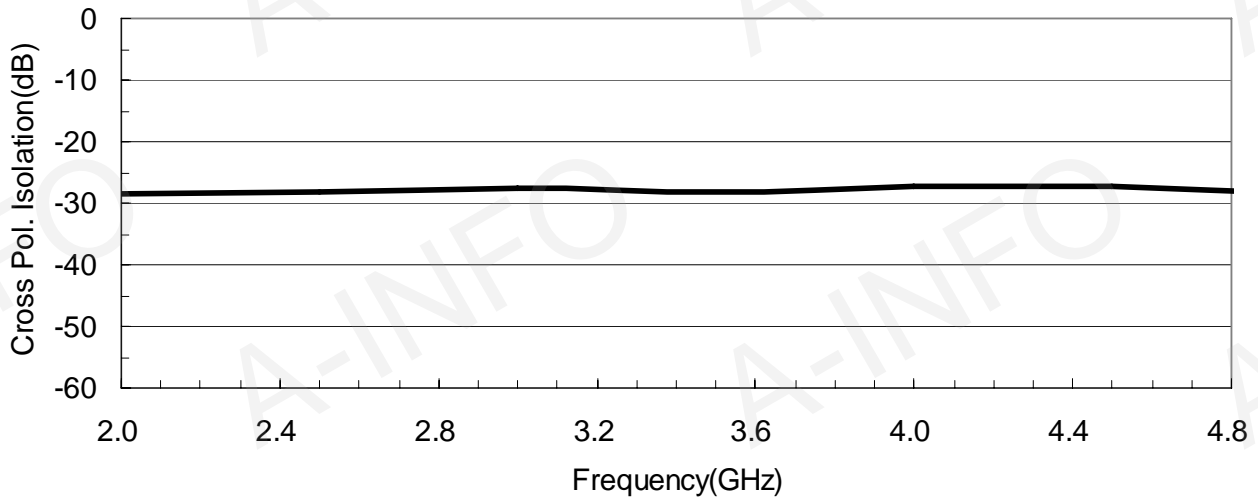

### 3. Pattern

Frequency: 2.0GHz

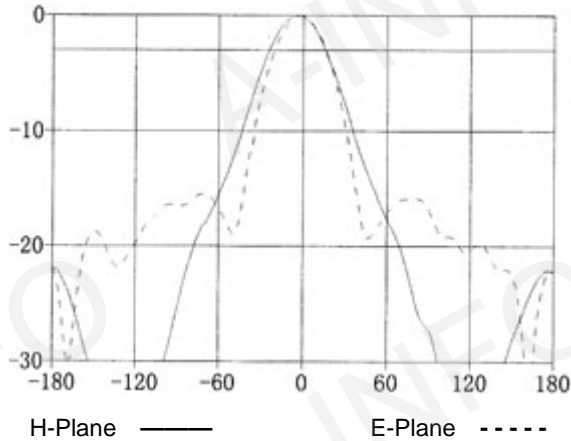

3dB Beamwidth (deg): 39.59    3dB Beamwidth (deg): 36.66

Frequency: 2.5GHz

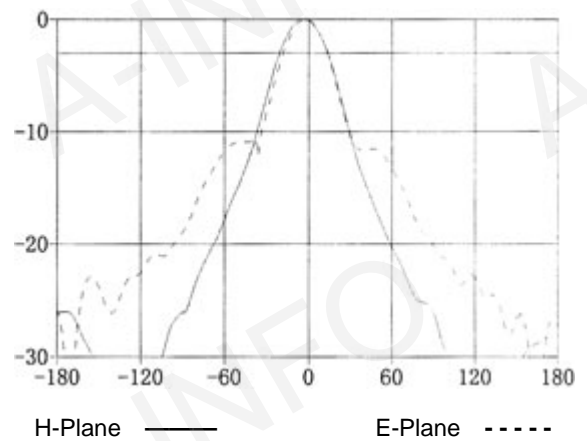

3dB Beamwidth (deg): 34.54    3dB Beamwidth (deg): 32.20

Frequency: 3.0GHz

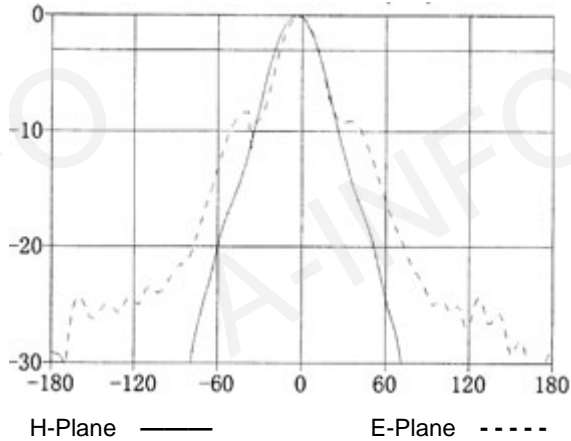

3dB Beamwidth (deg): 30.79    3dB Beamwidth (deg): 27.34

Frequency: 3.5GHz

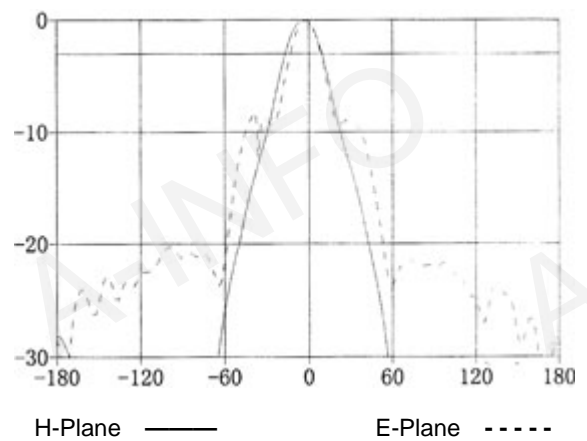

3dB Beamwidth (deg): 26.35    3dB Beamwidth (deg): 21.62

Frequency: 4.0GHz

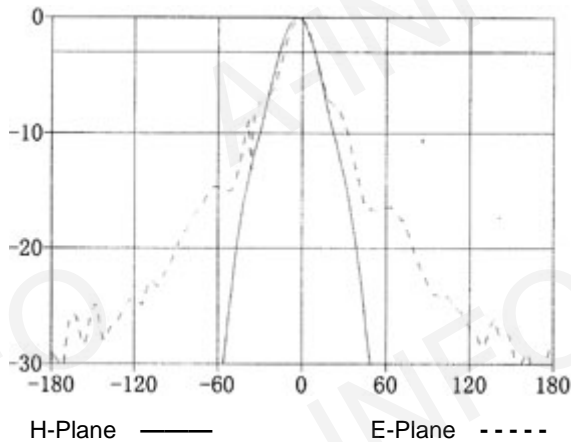

3dB Beamwidth (deg): 24.90    3dB Beamwidth (deg): 21.93

Frequency: 4.5GHz

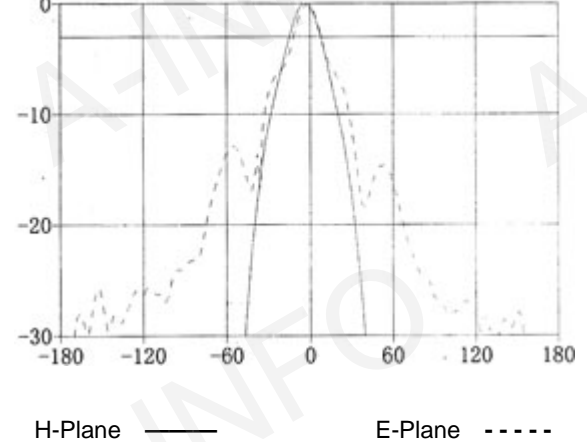

3dB Beamwidth (deg): 22.35    3dB Beamwidth (deg): 22.04

