



Test report is for reference only.

TEST REPORT
For
JXWBGL-D-1060-1120-23-30



Technical Specification

Frequency Range(GHz)	1.06-1.12
Insertion Loss(dB)	0.3 max
Isolation(dB)	23 min
VSWR	1.20 max
Forward Power(W)	30
Reverse Power(W)	10
Operating Temp. (°C)	-40~+70
Net Weight(Kg)	0.04

Outline Drawing (Size: mm)

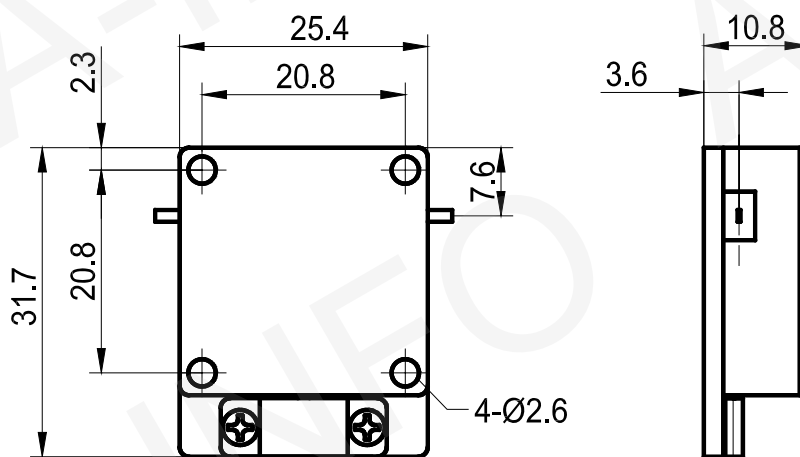

Test Results

1060MHz			1120MHz		
Insertion Loss (dB)	VSWR	Isolation (dB)	Insertion Loss (dB)	VSWR	Isolation (dB)
0.20	1.06	32.3	0.20	1.11	28.0